

■ ABSOLUTE MAXIMUM RATING (Ta=25°C)

PARAMETER	SYMBOL	RATING	UNIT
Power Supply Voltage	V ₊	7	V
Power Dissipation	P _D	1600(Note1)	mW
Operating Temperature Range	Topr	-40 ~ +85	°C
Storage Temperature Range	Tstg	-40 ~ +125	°C
Maximum Input Voltage	V _{IMAX}	0 ~ V ⁺ (Note2)	V

(Note1) EIA/JEDEC STANDARD Test board (76.2x114.3x1.6mm, 2layer, FR-4) mounting

■ OPERATING VOLTAGE

PARAMETER	SYMBOL	TEST CONDITION	MIN.	TYP.	MAX.	UNIT
Operating Voltage	V ⁺	-	3.9	5.0	5.5	V

■ ELECTRICAL CHARACTERISTICS (Ta=25°C, V⁺=5V, Vin=150mVrms/1kHz, MUT=CD=SPSW=V⁺, MON=OPEN, R_{VLC}=0Ω)

●Power Supply

PARAMETER	SYMBOL	TEST CONDITION	MIN.	TYP.	MAX.	UNIT
Operating Current 1	I _{CC1}	RX-mode (Receive)	2.0	3.5	6.0	mA
Operating Current 2	I _{CC2}	TX-mode (Transmit)	2.0	3.5	6.0	mA
Operating Current 3	I _{CC3}	Idle-mode (Standby)	2.0	3.5	6.0	mA
Operating Current 4	I _{CC4}	Idle-mode ,CD=PD	1.0	2.5	4.0	mA
Operating Current 5	I _{CC5}	Idle-mode ,CD=PD,SPSW=PD	0.5	1	1.5	mA
Reference Voltage	V _{REF}	No signal,Idle-mode	2.2	2.5	2.8	V

●Receive Attenuator(RxIN=200Vrms,Receive Amplifier Gv=0dB)

PARAMETER	SYMBOL	TEST CONDITION	MIN.	TYP.	MAX.	UNIT
Receive Attenuator Gain 1	G _{R1}	RX-mode (Receive)	3.0	6.0	9.0	dB
Receive Attenuator Gain 2	G _{R2}	TX-mode (Transmit)	-42	-46	-50	dB
Receive Attenuator Gain 3	G _{R3}	Idle-mode (Standby)	-17	-20	-23	dB
Range R to T mode	dG _R	RX-mode – TX-mode	47	52	57	dB
Dynamic DC offset	G _{RDC}	RX-mode – TX-mode (DC)	-50	-	50	mV
Volume control range	G _{RVR}	RX-mode,R _{VLC} =0Ω-100kΩ	35	45	55	dB

●Transmit Attenuator (TxIN=200Vrms,Mic.amplifier Gv=0dB)

PARAMETER	SYMBOL	TEST CONDITION	MIN.	TYP.	MAX.	UNIT
Transmit Attenuator Gain 1	G _{T1}	TX-mode (Transmit)	3.0	6.0	9.0	dB
Transmit Attenuator Gain 2	G _{T2}	RX-mode (Receive)	-42	-46	-50	dB
Transmit Attenuator Gain 3	G _{T3}	Idle-mode (Standby)	-17	-20	-23	dB
Range R to T mode	dG _T	TX-mode – RX-mode	47	52	57	dB
Dynamic DC offset	G _{TDC}	TX-mode – RX-mode (DC)	-50	-	50	mV

●MIC Amplifier(TxIN=1mVrms, Gv=40dB, RL=5.1kΩ)

PARAMETER	SYMBOL	TEST CONDITION	MIN.	TYP.	MAX.	UNIT
Output Offset Voltage	V _{MOS}	RF=300kΩ	-50	0.0	50	mV
Input Bias Current	I _{MBIAS}		-	30	-	nA
Voltage Gain 1	G _{VM1}	f=1kHz	-	40	-	dB
Voltage Gain 2	G _{VM2}	f=20kHz	-	36	-	dB
Maximum Output Voltage	V _{MMAX}	THD=1%	1.0	-	-	Vrms
Maximum Attenuation	G _{MMUTE}	MUT=MUTE	-70	-73	-	dB

●Receive Amplifier (RxIN=1mVrms, Gv=40dB, RL=5.1kΩ)

PARAMETER	SYMBOL	TEST CONDITION	MIN.	TYP.	MAX.	UNIT
Output Offset Voltage	V _{ROS}	RF=300kΩ	-50	0.0	50	mV
Input Bias Current	I _{RBIAS}		-	30	-	nA
Voltage Gain 1	G _{VR1}	f=1kHz	-	40	-	dB
Voltage Gain 2	G _{VR2}	f=20kHz	-	36	-	dB
Maximum Output Voltage	V _{RMAX}	THD=1%	1.0	-	-	Vrms

●Line Amplifier (LINEIN=50mVrms, Gv=26dB, RL=1.2kΩ)

PARAMETER	SYMBOL	TEST CONDITION	MIN.	TYP.	MAX.	UNIT
Output Offset Voltage	V _{LOS}	RF=51kΩ	-50	0.0	50	mV
Input Bias Current	I _{RBIAS}		-	30	-	nA
Voltage Gain 1	G _{VL1}	f=1kHz	-	26	-	nA
Voltage Gain 2	G _{VL2}	f=20kHz	-	25	-	nA
Gain Bandwidth	G _{LBW}	RL=600Ω, LIO	-	1.5	-	MHz
Closed Loop Gain	G _{LC}	RL=1.2kΩ, LIO- to LIO+	-0.5	0	0.5	dB
Maximum Output Voltage	V _{LMAX}	RL=1.2kΩ, THD=1%	2.0	-	-	Vrms
Total Harmonic Distortion	THD _{LN}	VIN=100mVrms, Gv=20dB RL=1.2Ω	-	-	0.5	%

●Speaker Amplifier (SPIN=50mVrms, Gv=26dB, RL=32Ω)

PARAMETER	SYMBOL	TEST CONDITION	MIN.	TYP.	MAX.	UNIT
Output Offset Voltage	V _{SPOS}	RF=51kΩ	-50	0.0	50	mV
Voltage Gain 1	G _{VSP1}	f=1kHz	-	26	-	dB
Voltage Gain 2	G _{VSP2}	f=20kHz	-	24	-	dB
Voltage Gain 3	G _{VSP3}	f=1kHz, G _{VSP} =6dB, RL=8Ω	-	6	-	dB
Voltage Gain 4	G _{VSO4}	f=20kHz, G _{VSP} =6dB, RL=8Ω	-	4	-	dB
Closed Loop Gain	G _{LC}	SPO- to SPO+	-0.6	0	0.6	dB
Maximum Output Power	P _{OMAX1}	RL=32Ω, THD=3%	200	300	-	mW
	P _{OMAX2}	RL=8Ω, THD=3%	300	500	-	mW
Total Harmonic Distortion	THD _{SP1}	VIN=500mVrms, f=1KHz, RL=32Ω, G _{VD} =26dB		-	1.0	%
	THD _{SP2}	VIN=500mVrms, f=1KHz, RL=8Ω, G _{VD} =6dB	-	-	1.0	%

●MONITOR TERMINAL (32Pin)

PARAMETER	SYMBOL	TEST CONDITION	MIN.	TYP.	MAX.	UNIT
Rx-mode	Rx	-	$V^+ - 0.6$	-	V^+	V
Tx-mode	Tx	-	GND	-	0.6	V
Idle-mode	Idle	No Signal	2.4	2.5	2.6	V
Maximum Output Current	I_{MON}	Rx-mode / Tx-mode	-	0.9	-	mA

■ CONTROL CHARACTERISTICS (MUT)

PARAMETER	SYMBOL	TEST CONDITION	MIN.	TYP.	MAX.	UNIT
Low Level Input Voltage	V_{IL1}	-	-	-	0.3	V
High Level Input Voltage	V_{IH1}	-	1.5	-	-	V

■ CONTROL CHARACTERISTICS (RTSW)

PARAMETER	SYMBOL	TEST CONDITION	MIN.	TYP.	MAX.	UNIT
Low Level Input Voltage	V_{IL2}	-	-	-	0.3	V
High Level Input Voltage	V_{IH2}	-	$V^+ - 0.3$	-	-	V

■ FUNCTION

●CD

INPUT VOLTAGE	STATUS	OPERATION
V_{IH}	ACTIVE	NJW1128 is active.
V_{IL}	MUTE	NJW1128 is stand-by except Speaker Amplifier.

●MUT

INPUT VOLTAGE	STATUS	OPERATION
V_{IH}	MUTE	The microphone input is mute.
V_{IL}	ACTIVE	The microphone input is active.

●SPSW

INPUT VOLTAGE	STATUS	OPERATION
V_{IH}	ACTIVE	The Speaker Amplifier is Active.
V_{IL}	PD	The Speaker Amplifier is Stand-by.

●RTSW

INPUT VOLTAGE	STATUS	OPERATION
V_{IH}	Receive	Force to Receive mode.
OPEN	AUTO	Receive mode and Transmit mode are automatically switched.
V_{IL}	Transmit	Force to Transmit mode.

● R_{VLC} (26pin)

IMPEDANCE	STATUS	OPERATION
0	Vol_{MAM}	The Receive attenuator Volume is maximum.
100k Ω	Vol_{MIN}	The Receive attenuator Volume is minimum.

APPLICATION CIRCUIT

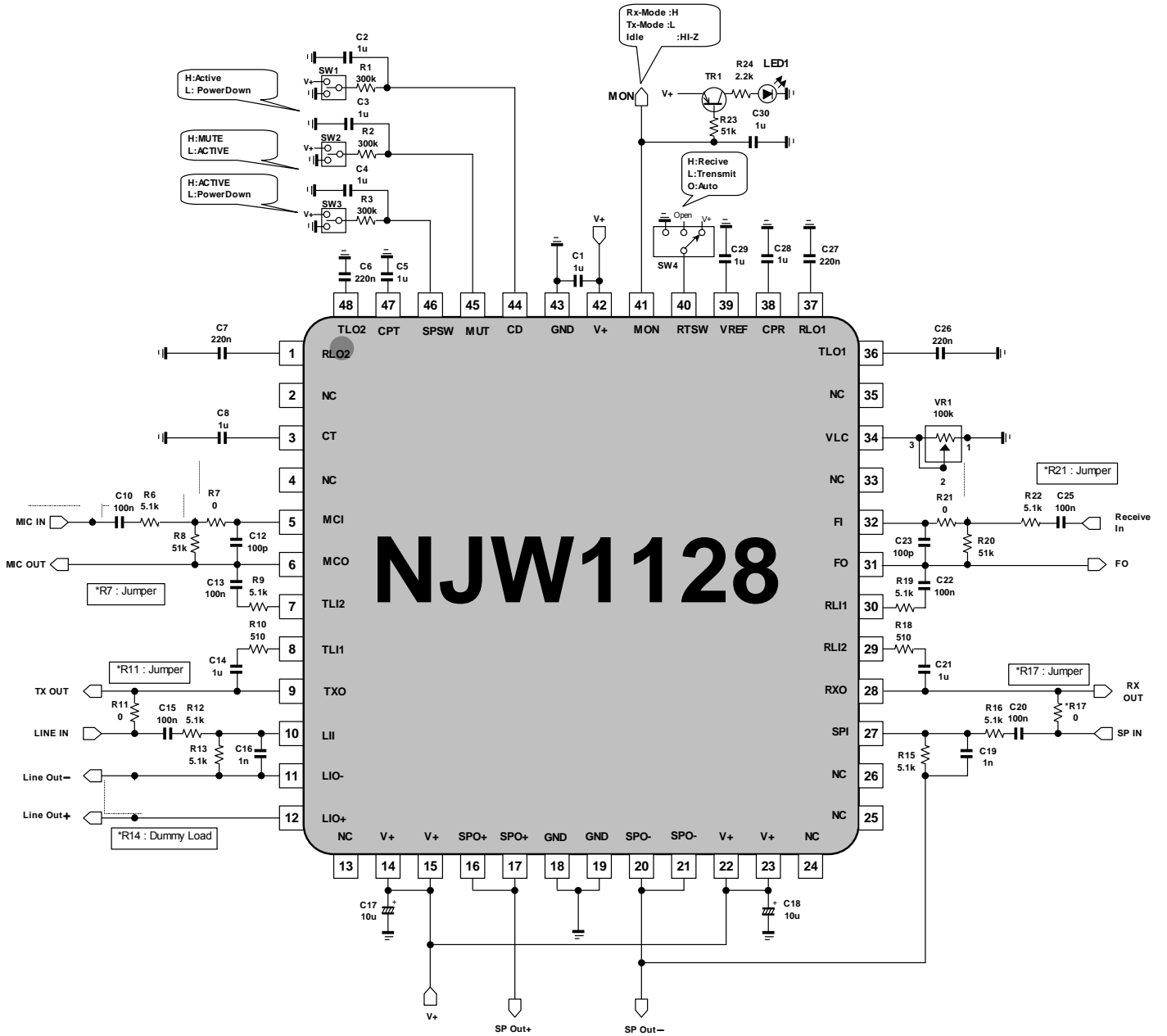

TYPICAL CHARACTERISTICS

Supply Current vs Supply Voltage
No Signal, Supply Current 1

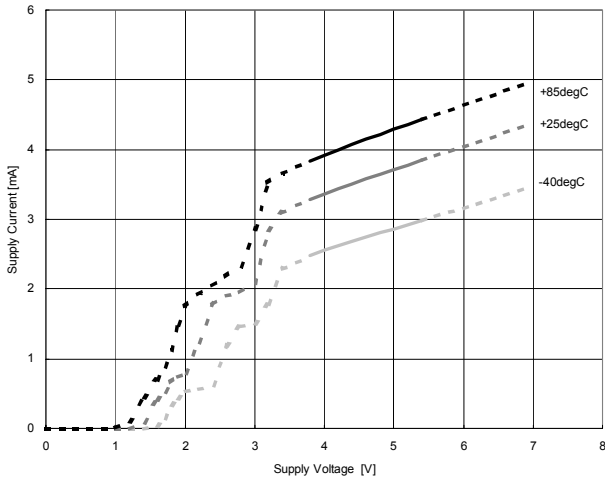

Supply Current vs Supply Voltage
No Signal, Supply Current 4

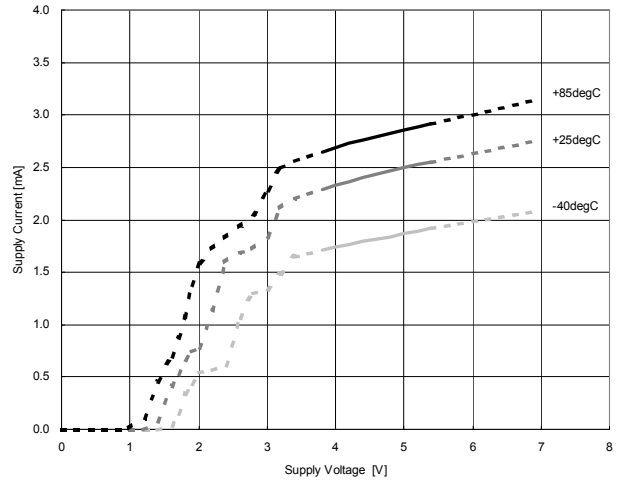

Supply Current vs Supply Voltage
No Signal, Supply Current 5

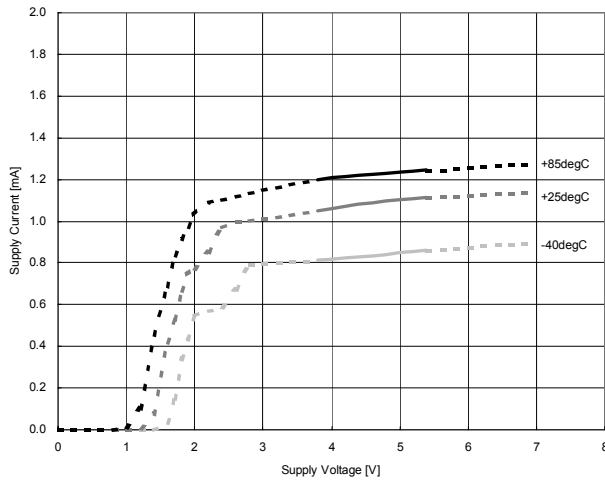

Supply Current vs Temperature
V+ =5.0V, No Signal

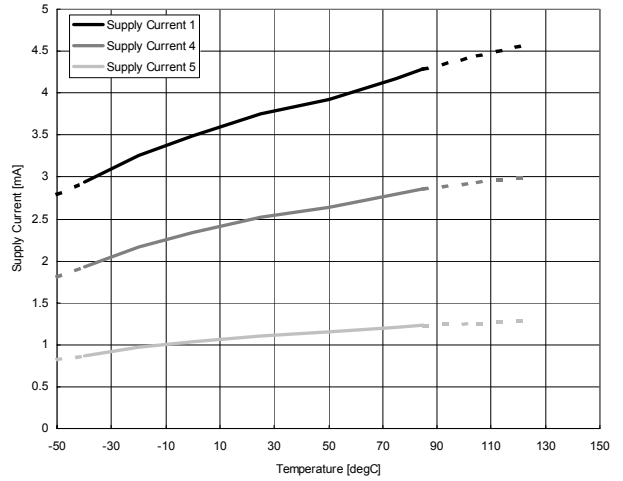

RxAtt Gain vs Temperature
V+ =5.0V, RecieveAmp : 0dB, RL=5.1k Ω

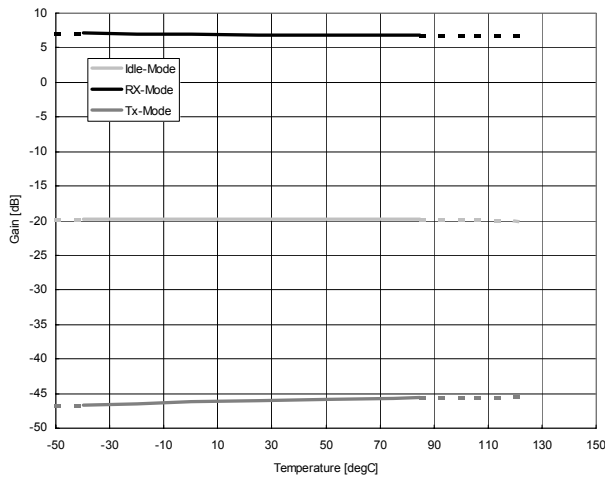

RxAtt Gain vs Temperature
V+ =5.0V, Rx-Mode, RecieveAmp : 0dB, RL=5.1k Ω

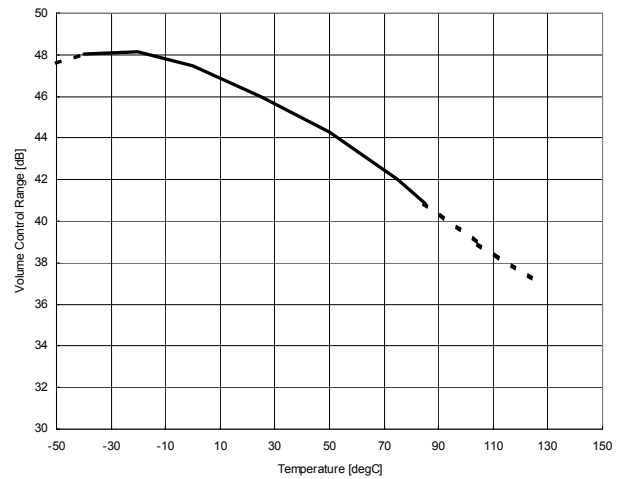

TYPICAL CHARACTERISTICS

TxAmp Gain vs Temperature
 $V+ = 5.0V$, MicAmp: 0dB, $R_L = 5.1k\Omega$

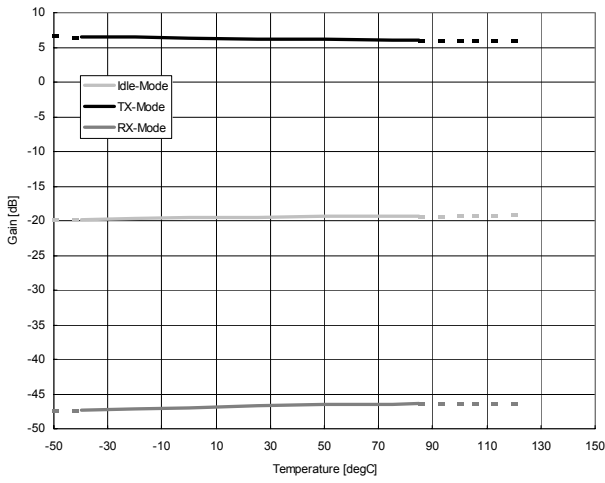

RecieveAmp Maximum Output Voltage vs Temperature
 $V+ = 5.0V$, $f = 1kHz$, $R_f = 300k\Omega$, $G_v = 40dB$, $R_L = 5.1k\Omega$, THD+N = 1%, BW=400Hz-30kHz

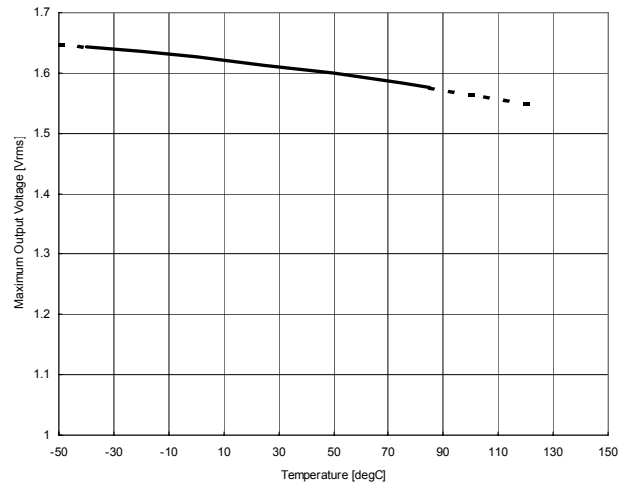

McAmp Maximum Output Voltage vs Temperature
 $V+ = 5.0V$, $f = 1kHz$, $R_f = 300k\Omega$, $G_v = 40dB$, $R_L = 5.1k\Omega$, THD+N = 1%, BW=400Hz-30kHz

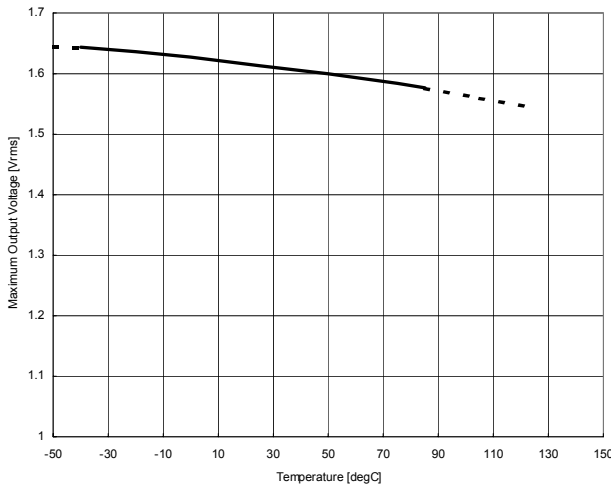

McAmp Mute Range vs Temperature
 $V+ = 5.0V$, $R_f = 300k\Omega$, $G_v = 40dB$, $R_L = 5.1k\Omega$, A-Weighting

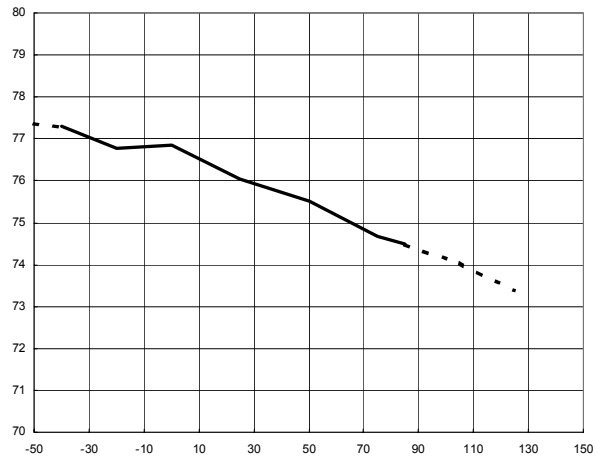

LineAmp THD vs Temperature
 $V+ = 5.0V$, $f = 1kHz$, $R_f = 51k\Omega$, $G_v = 26dB$, $V_{in} = 50mV_{rms}$, $R_L = 1.2k\Omega$, BW=400Hz-30kHz

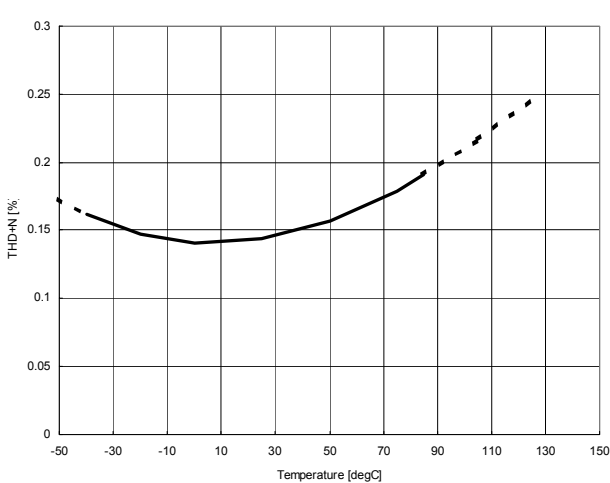

LineAmp Maximum Output Voltage vs Temperature
 $V+ = 5.0V$, $f = 1kHz$, $R_f = 51k\Omega$, $G_v = 26dB$, $R_L = 1.2k\Omega$, THD+N = 1%, BW=400Hz-30kHz

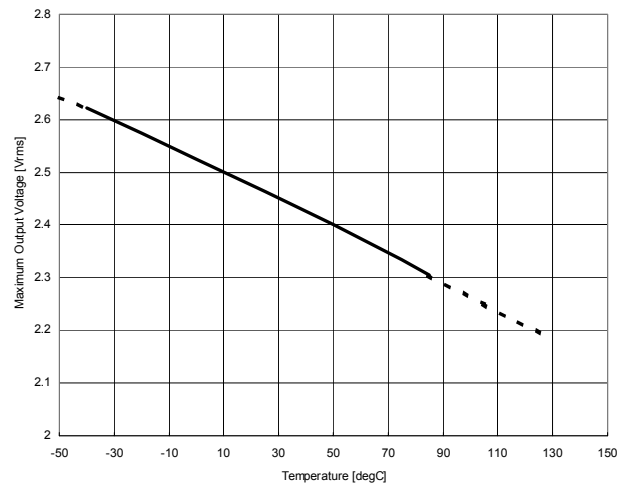

TYPICAL CHARACTERISTICS

Speaker Amp THD+N vs Temperature
 $V+ = 5.0V$, $f = 1kHz$, $BW=400Hz-30kHz$

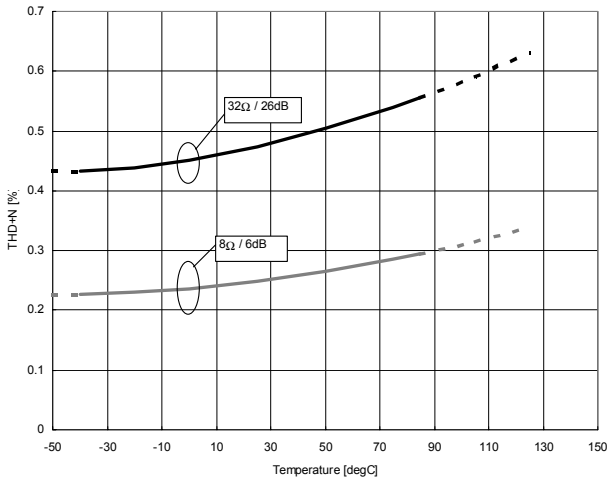

Speaker Amp Maximum Output Power vs Temperature
 $V+ = 5.0V$, $f = 1kHz$, $THD+N = 3%$, $BW=400Hz-30kHz$

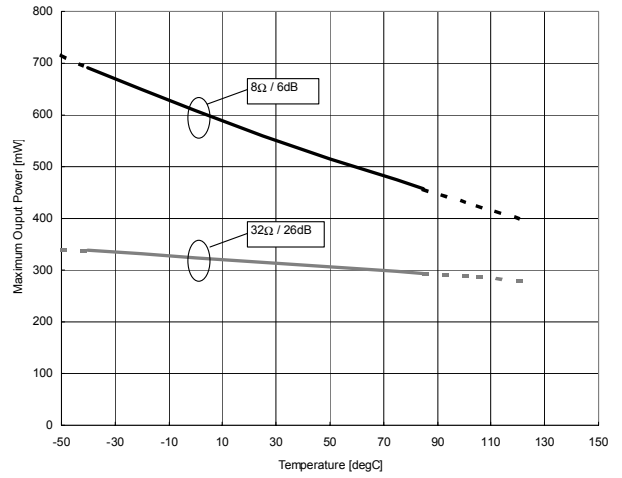

Receive Amp THD+N vs Input Voltage
 $V+ = 5.0V$, $f = 1kHz$, $Rf = 3k\Omega$, $Ri = 3k\Omega$, $Ci = 1\mu F$, $Gv = 0dB$, $RL = 5.1k\Omega$, $BW=400Hz-30kHz$

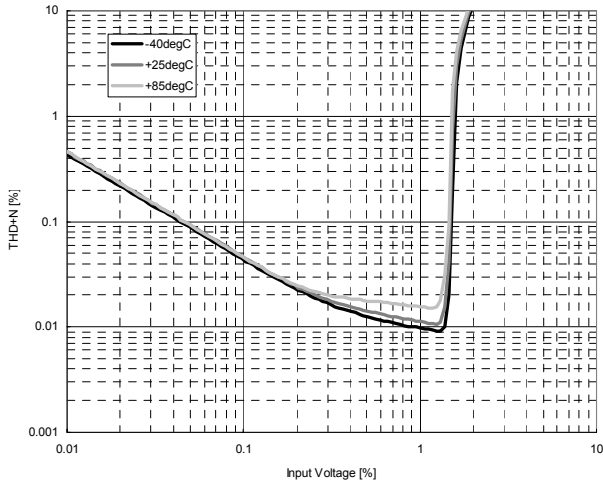

Receive Amp THD+N vs Input Voltage
 $V+ = 5.0V$, $f = 1kHz$, $Rf = 300k\Omega$, $Ri = 3k\Omega$, $Ci = 1\mu F$, $Gv = 40dB$, $RL = 5.1k\Omega$, $BW=400Hz-30kHz$

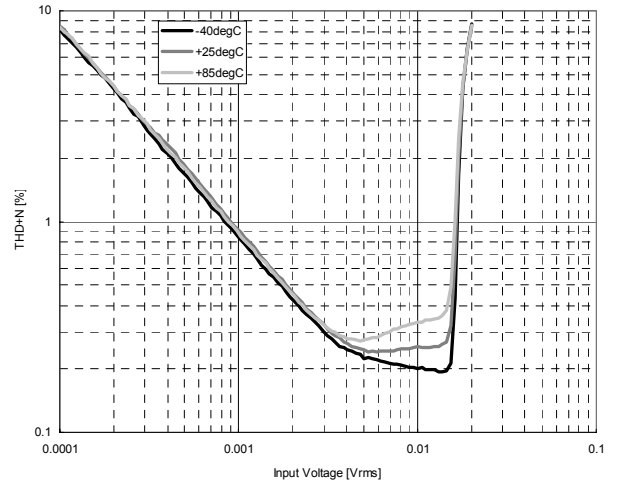

Mic Amp THD+N vs Input Voltage
 $f = 1kHz$, $Rf = 3k\Omega$, $Ri = 3k\Omega$, $Ci = 1\mu F$, $Gv = 0dB$, $RL = 5.1k\Omega$, $BW=400Hz-30kHz$, $Ta = -40degC$

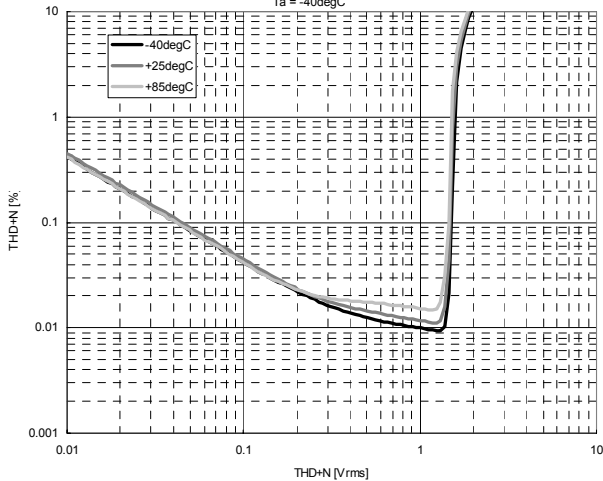

Mic Amp THD+N vs Input Voltage
 $V+ = 5.0V$, $f = 1kHz$, $Rf = 300k\Omega$, $Ri = 3k\Omega$, $Ci = 1\mu F$, $Gv = 40dB$, $RL = 5.1k\Omega$, $BW=400Hz-30kHz$

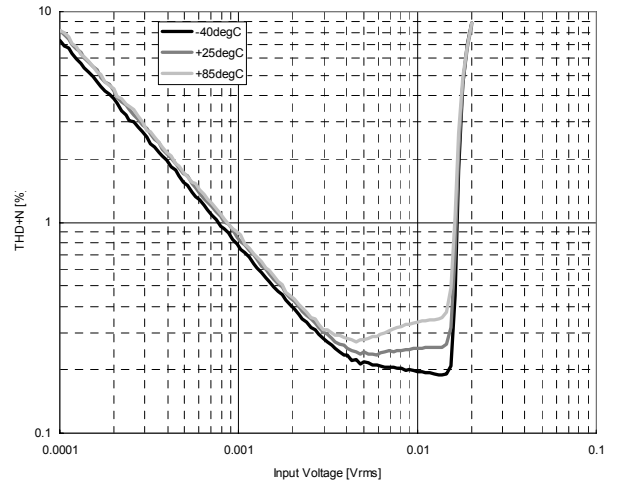

TYPICAL CHARACTERISTICS

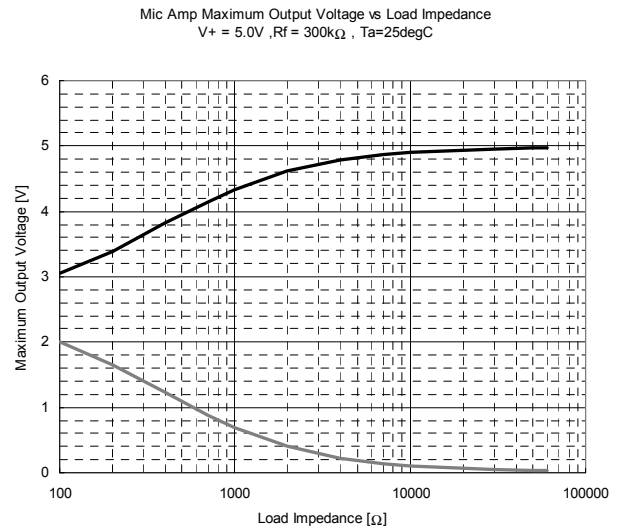
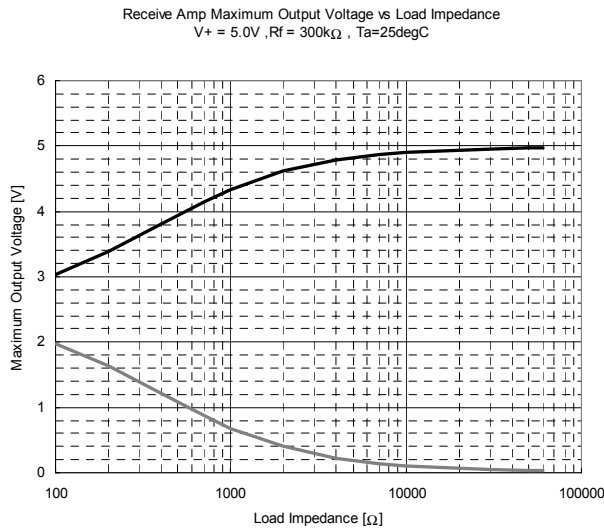
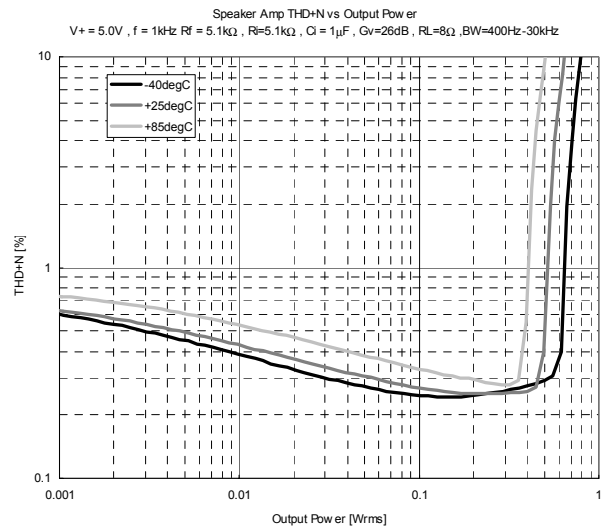
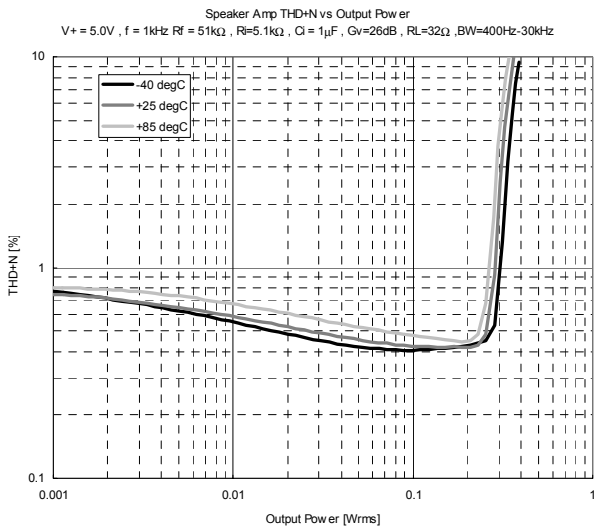
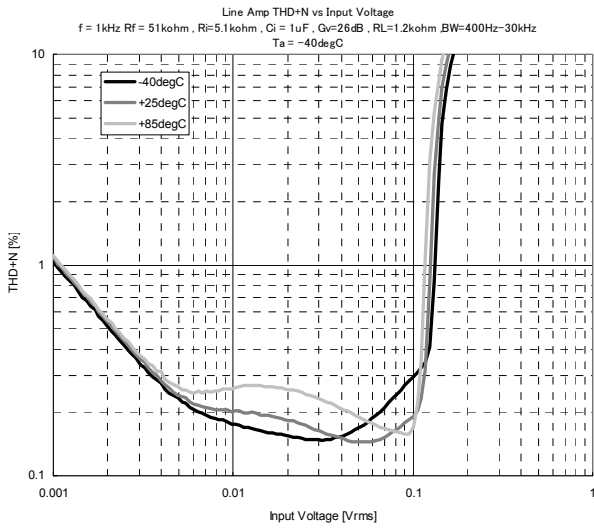

TYPICAL CHARACTERISTICS

Rx Att Maximum Output Voltage vs Load Impedance
 $V+ = 5.0V$, $T_a = 25\text{degC}$

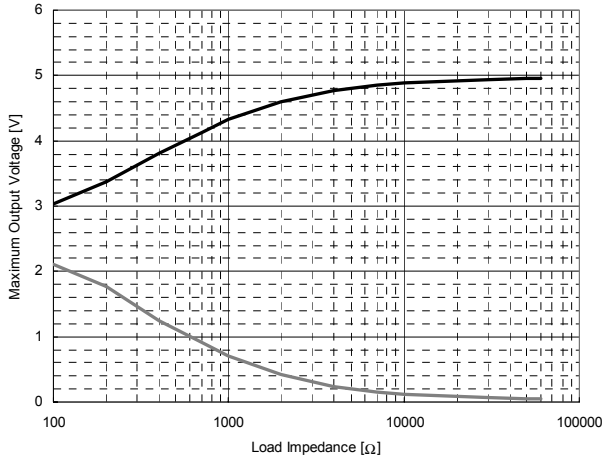

Tx Att Maximum Output Voltage vs Load Impedance
 $V+ = 5.0V$, $T_a = 25\text{degC}$

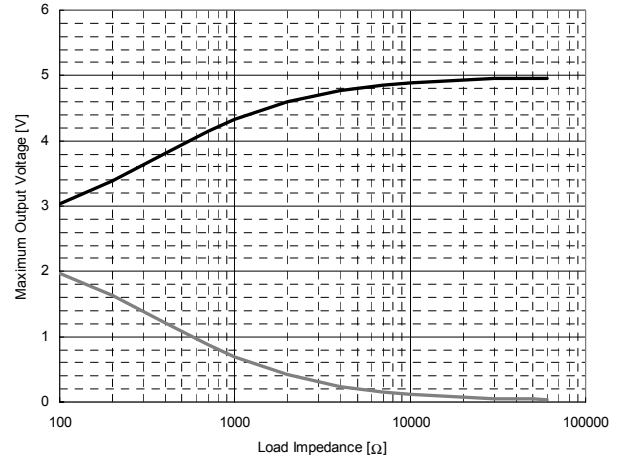

Line Amp Maximum Output Voltage vs Load Impedance
 $V+ = 5.0V$, $R_f = 51k\Omega$, $T_a = 25\text{degC}$

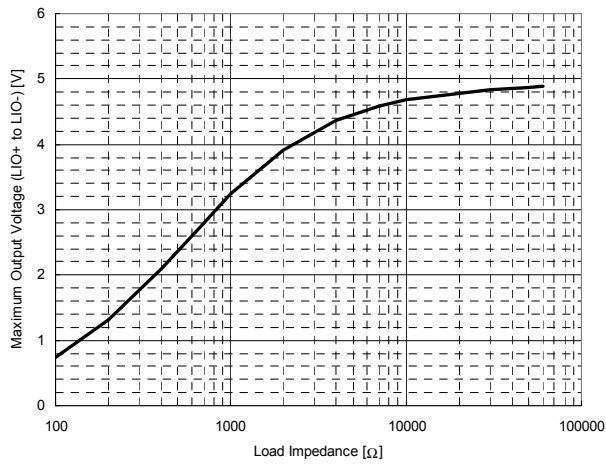

Monitor out Maximum Output Voltage vs Load Impedance
 $V+ = 5.0V$, $T_a = 25\text{degC}$

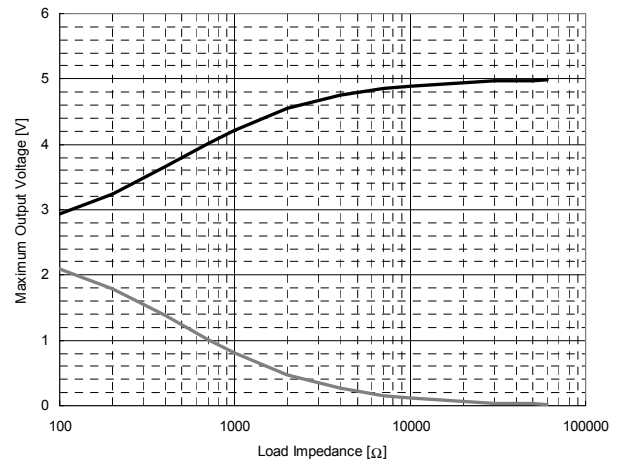

TYPICAL CHARACTERISTICS

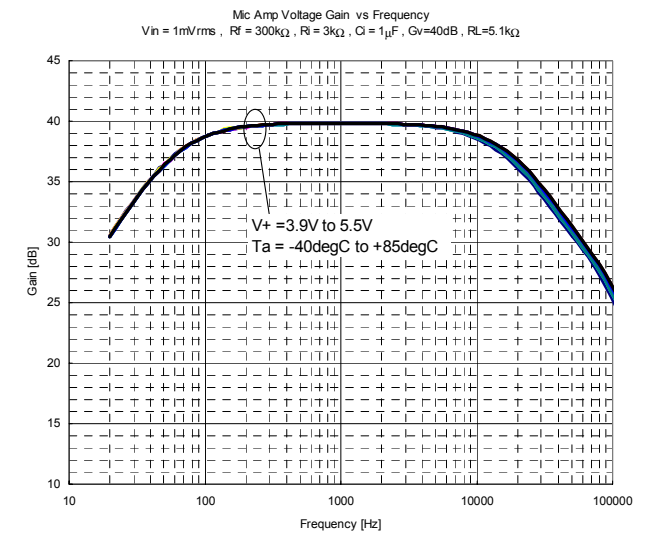
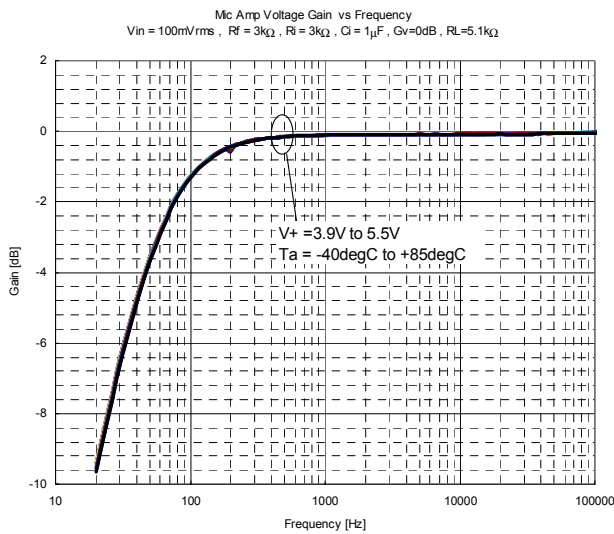
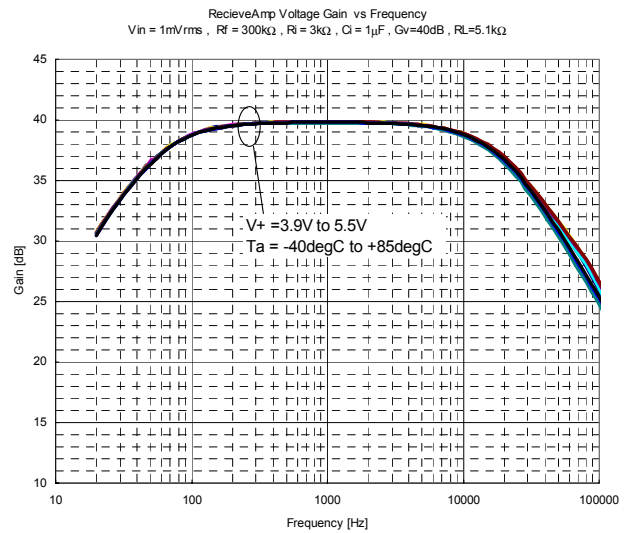
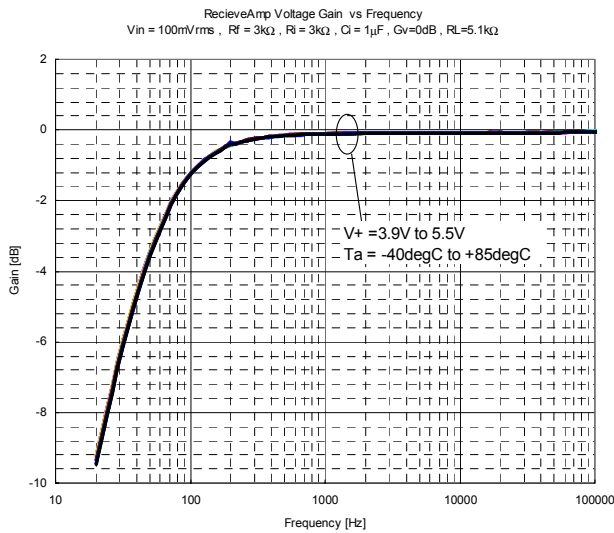
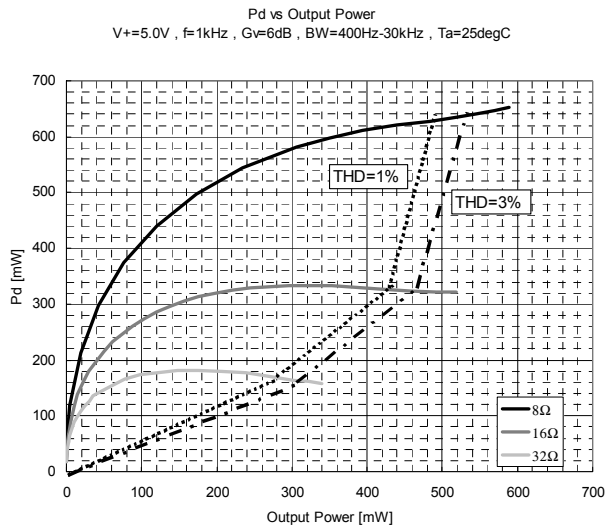

TYPICAL CHARACTERISTICS

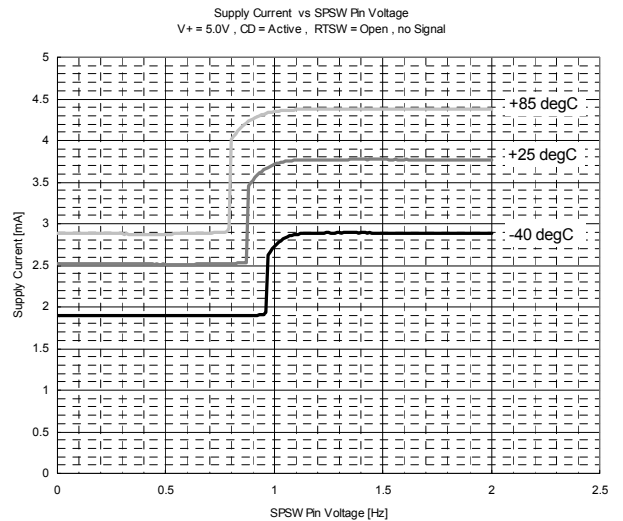
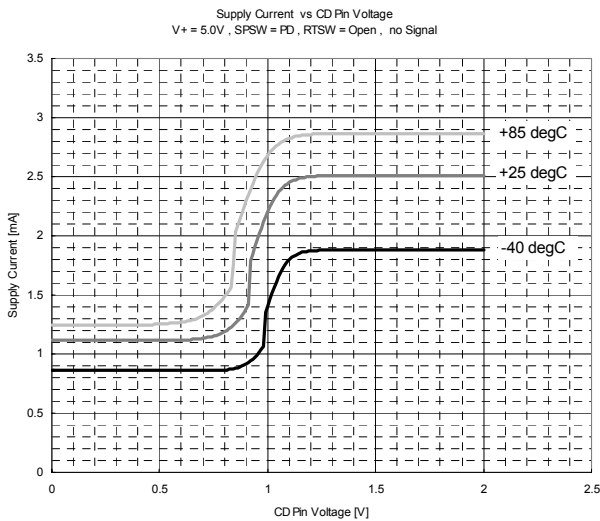
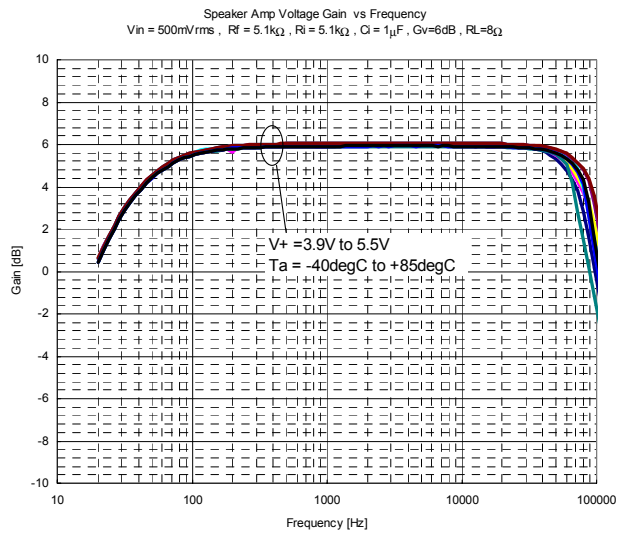
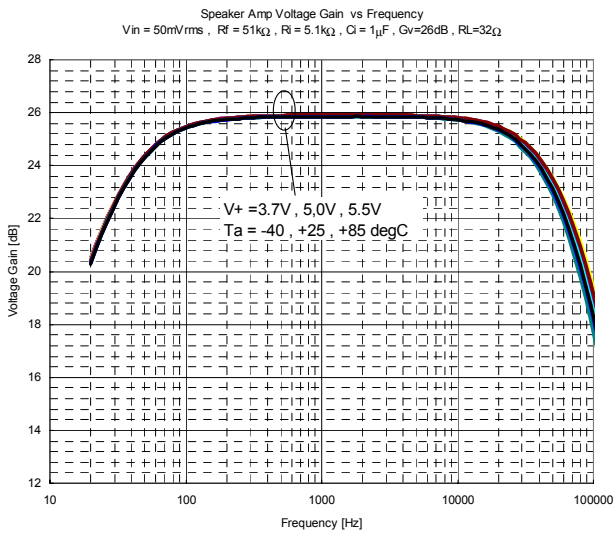
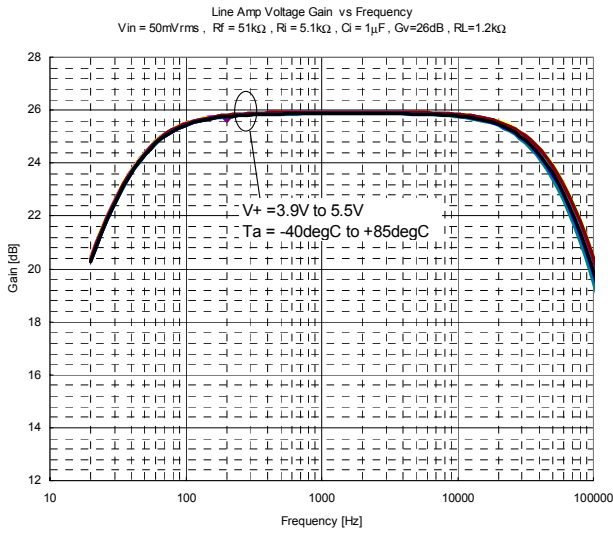

TYPICAL CHARACTERISTICS

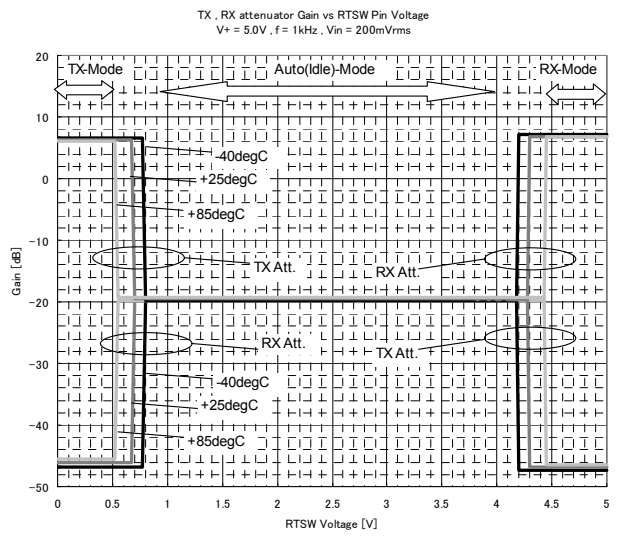
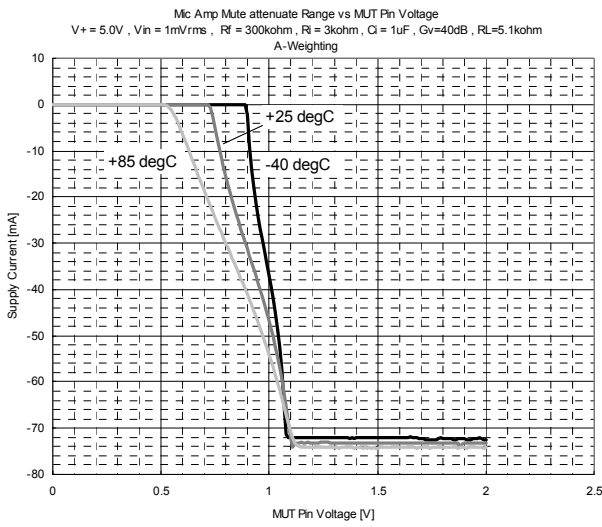

distributed by:



1 300 785 911

[CAUTION]

The specifications on this databook are only given for information, without any guarantee as regards either mistakes or omissions. The application circuits in this databook are described only to show representative usages of the product and not intended for the guarantee or permission of any right including the industrial rights.